

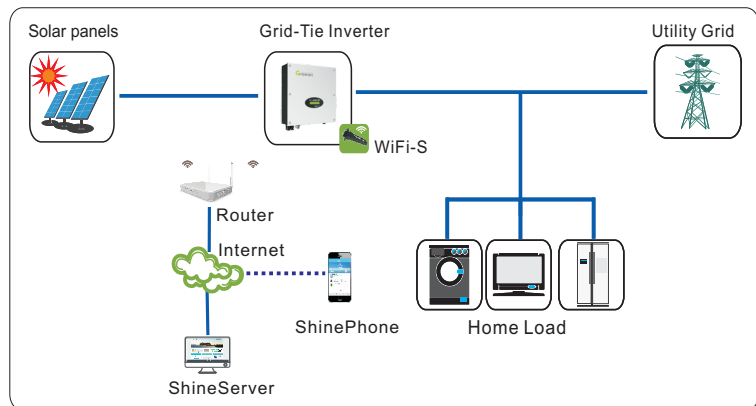

Newly recommended for house-owners

- ▶ Easy to use
- ▶ Plug-and-play commissioning
- ▶ 50-meter wireless connection to inverter
- ▶ Remote firmware updating for inverter
- ▶ Free online monitoring via Shine Server



Datasheet

ShineWiFi-S

Wireless Parameters

Wireless standard	802.11 b/g/n
Frequency range	2412M ~ 2484M
Transmit power	802.11b: 16±2 dBm (@11Mbps) 802.11g: 14±2 dBm (@54Mbps) 802.11n: 13±2 dBm (@HT20, MCS7)
Receiver sensitivity	CCK, 1 Mbps : -90dBm CCK, 11 Mbps: -85dBm 6 Mbps (½ BPSK): -88dBm 54 Mbps (¾ 64-QAM): -70dBm Ht20, MCS7 (65 Mbps, 72.2 Mbps): -67dBm

Hardware Parameters

Data interface	RS232(Modbus RTU protocol)
Operating voltage	9V(+/-15%)
Operating current	100mA

Application on Parameters

Supported servers	ShineServer
Inverter communication	RS232(Modbus RTU protocol)
Server communication	TCP(Modbus TCP protocol)
Support network	2.4G WiFi
Max. communication range	50m
Max. power consumption@transmit	1.2W
Configure type	APP configure
Data transfer interval	5 Minutes
Default server URL	server.growatt.com

General Data

Dimensions(Length/Width/Height)	135/79/29 mm
Weight	60g
Manual language	English, Chinese
Operating temperature	-40°C ~ +85°C
Warranty	1 years

Certification

CE